

SHENZHEN SUNFAR ELECTRIC TECHNOLOGIES CO.,LTD

✧ PREFACE

Thanks very much for choosing our E300 Series Mini-type Integrated Universal Inverter.

This manual provides guidance of using inverter safely and carefully, containing introduction of installation, wiring, parameter list, routine maintenance, operating rules and cautions, etc.

In order to make good use of inverter properly and safely, please read this manual thoroughly before using. It may lead to abnormal operation or failure, reduce using life, even damage equipment and cause personal injury if use it wrongly.

This manual is attached together with inverter. Please keep it well and it would be available for engineering and installation personnel, repairing and maintaining during product functioning period. SUNFAR has the right to modify and improve products, data and dimensions without notice, so this manual is updated and all contents in this manual are subject to change without any notice.



SHENZHEN SUNFAR ELECTRIC TECHNOLOGIES CO., Ltd.

E300 Series Mini-type Integrated Universal Inverter Manual

Version: V1.1

Time: Aug. 2009

CONTENT

1 INTRODUCTION	1
1.1 Model Explanation	1
1.2 Inverter Model	1
1.3 Appearance	1
1.4 Specification Data	2
2 INSTALLATION	3
2.1 Environmental Requirements	3
2.2 Installation Dimension	4
3 WIRING	7
3.1 Precautions	7
3.2 Wiring of External Components	8
3.3 Basic Wiring	9
3.4 Wiring of Main Loop Terminal	9
3.5 Wiring of Control Loop Terminal	10
3.6 Wiring of RS485 Interface and External Keyboard	11
4 PANEL OPERATION	12
4.1 Key Function Description	12
4.2 Panel Operational Method	13
4.3 State Monitor Parameter List	14
4.4 Inverter Simple Operation	14
5 PARAMETER LIST	16
6 DESCRIPTION OF SPECIFIC FUNCTIONS	20
6.1 Basic operation parameter unit	20
6.2 I/O parameter unit	25
6.3 Auxiliary running parameter unit	30

6.4	Multi-speed and advanced running parameter unit.....	33
6.5	Communication function parameter unit	35
7	FAULT DIAGNOSIS AND COUNTERMEASURES	37
7.1	Protective Function and Countermeasures	37
7.2	Fault Record Inquiry.....	38
7.3	Reset.....	38
Appendix I	: RS485 COMMUNICATION PROTOCOL	39
1.1	Summary.....	39
1.2	BUS Structure and Protocol Description.....	39
1.3	Frame Format Description	44
1.4	Example	49
Appendix II	: MODBUS PROTOCOL.....	54
1.1	Protocol Format Explanation.....	54
1.2	Example	58
Appendix III	: BRAKING RESISTOR	60

PRECAUTIONS

In order to use inverter properly and safely, please read this manual carefully before using. You should follow the requirements of this manual to move, install, run, operate and repair etc.

1. Opening

- I Please check any damage that may have occurred during transportation.
 II Please check whether inverter nameplate data is in accordance with your order, if anything wrong, please contact supplier immediately.

Our product is manufactured, packed and transported in strict quality control system. But in case there is any error, please contact our company or local agent. We will solve the problem as quickly as possible.

Inverter nameplate data

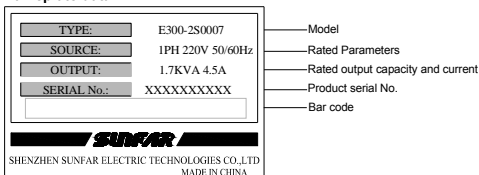
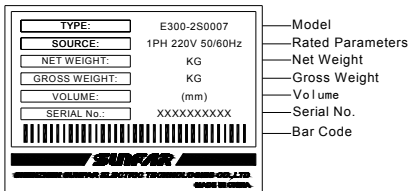

Fig-1 Nameplate

Package data



Dimension

Model	Net Weight (KG)	Gross Weight (KG)	Dimension (mm)
E300-2S0002(B)	0.78	0.97	195×115×175
E300-2S0004(B)	0.82	1.00	195×115×175
E300-4T0007(B) / E300-2S0007(B)	1.43	1.73	223×135×195
E300-4T0015(B) / E300-2S0015(B)	1.54	1.84	223×135×195
E300-4T0022(B)	1.78	2.50	270×160×215
E300-4T0037(B) / E300-2S0022(B)	1.82	2.54	270×160×215

2. Safety Regulations

There are four kinds of symbols being related with cautions as following:



Danger: If user does not operate according to requirements, it will lead to death, grievous bodily harm or severe property loss.



Warning: If user does not operate according to requirements, it will lead to inverter injury or damage.



This symbol will offer some useful information.



This symbol will offer some items that need to be noticed in operation.

2.1 Installing

- 2.1.1. Do not install inverter on combustible material.
- 2.1.2. Do not install in explosive ambient.
- 2.1.3. Do not drop other material into inverter.



It is forbidden to disassemble and refit inverter.

2.2 Wiring

- 2.1.4. It must be operated by professional worker when wiring.
- 2.1.5. Please be sure to turn off the power supply at least 10 min before wiring.
- 2.1.6. Inverter and motor must be grounded correctly.
- 2.1.7. Be sure to wire and inspect after power-off at least 10 minutes.
- 2.1.8. Electron components are sensitive about static electricity, so do not drop other material into inverter or touch the main circuit.



It is forbidden to connect AC power supply with the U, V and W output terminals directly.

2.3 Maintenance



Do not touch radiator after power-off at least 10 minutes.

3. Attention Notes:

- 2.1.9. Be sure to install inverter in a well-ventilated ambient.
- 2.1.10. Motor temperature under inverter control will be higher than at main supply control, which is normal phenomenon.
- 2.1.11. Normal motor cannot run at low speed for a long time, so user should select special motor for inverter or reduce motor load under low speed.
- 2.1.12. When altitude is over 1000m, inverter will be valid to decrease rated current, and rated current will decrease 10% when altitude is increased 1500m.



Be sure not to connect inverter output terminals with filter capacitors or other surge absorbers.

4 Dispose:

When you dispose inverter and its parts, please pay attention to:

Capacitor: The capacitors in inverter may explode when they are burned.

Plastic: Poisonous gas may be generated when front panel is burned, please pay attention to waste gas when plastic parts are burned.

Method: Please dispose inverter as industry waste.

1 INTRODUCTION

1.1 Model Explanation

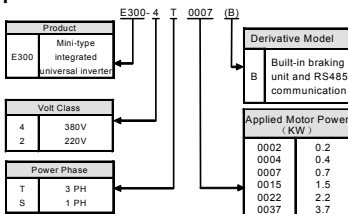

1.2 Inverter Model

Model	Rated Capacity (KVA)	Rated Output Current (A)	Applied Motor Power (KW)
E300-2S0002(B)	0.69	1.8	0.25
E300-2S0004(B)	0.95	2.5	0.4
E300-2S0007(B)	1.7	4.5	0.75
E300-2S0015(B)	2.9	7.5	1.5
E300-2S0022(B)	3.8	10.0	2.2
E300-4T0007(B)	1.6	2.5	0.75
E300-4T0015(B)	2.8	4.2	1.5
E300-4T0022(B)	3.6	5.5	2.2
E300-4T0037(B)	5.6	8.5	3.7

1.3 Appearance

1.3.1 Type One

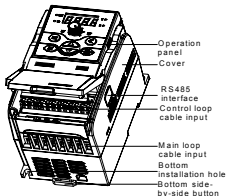

Fig 1-1 Type I

Suitable model: E300-2S0002(B) /
E300-2S0004(B)

1.3.2 Type Two

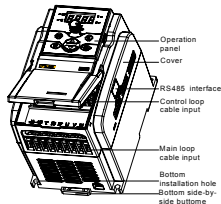

Fig 1-2 Type II

Suitable model: E300-2S0007(B)~E300-2S0022(B) /
E300-4T0007(B)~E300-4T0037(B)

1.4 Specification Data

E300 series power range: 2S0002(B) ~2S0022(B) and 4T0007(B) ~4T0037(B).

E300 series specification data and typical functions:

Input	Rated volt and freq		3 PH (4T****) 380V 50/60 Hz	1 PH (2S****) 220V 50/60 Hz
	Permissible volt range		320V ~ 460V	170V ~ 270V
Output	Volt		0 ~ 380V	0~220V
	Freq		0~1000 Hz	
	Overload Endurance		110% for long-term; 150% for 1m; 180% for 2s	
Control Mode			V/F control	
Control Characteristics	Freq setting Resolution	Analog Input	0.4% of maximum output freq	
		Digital Input	0.1 Hz	
	Freq Precision	Analog Input	Within 0.4% of maximum output freq	
		Digital Input	Within 0.1% of setting freq	
	V/F control	Torque boost	Manual set: 0.0~20.0% of rated output	
		Auto current/volt limit	It will check motor stator current and volt automatically based on special arithmetic to control within allowable range to ensure minimum failure during acc/ dec or stable running.	
Typical Function	Multi-speed control		Seven programmable multi-speed control, three multi-speed control terminal	
	RS485 communication (E300B series)		Standard built-in RS485 interface, RS485 communication protocol and MODBUS for choice	
	Freq setting	Analog input	Panel potentiometer setting, DC volt 0~10V, DC current 0~20mA	
		Digital input	Operation panel setting, RS485 interface setting, UP/DW terminal control	
	Output Signal	Relay and OC output	One OC output and one relay output (TA, TB, TC) as many as 9 types for choice	
		Analog output	One 0~10V volt signal	
	Acc /dec time setting		0.1~600s continuous setting, S curve and linear mode for choice	
	DC braking		Action freq 0~500.0 Hz, action time 0~20.0 S	
	Low noise running		Carrier wave freq 1.5 KHz ~ 12.0 KHz continuous adjustment to ensure the lowest motor noise.	
Running function		Upper and Lower freq setting, reversal operating restriction, RS485 communication,, freq increasing / decreasing control etc.		
Display	Operation panel display	Running state	Output freq, current and volt, motor rotate speed, freq setting, module temperature, analog I/O	
		Warning	Last four times failure record, output freq, current, volt and DC volt of last fault trip for running parameter record	
Protection / warning function			Over current, over volt, under volt, overheating, short circuit etc.	

2 INSTALLATION

2.1 Environmental Requirements



Ambient temperature should be in range of $-10^{\circ}\text{C} - 40^{\circ}\text{C}$.
 Please avoid putting inverter in a high temperature and moist location.
 The humidity is less than 90% and non-condensing.
 Avoid sunshine directly.
 Keep away from combustible, explosive material and caustic gas or liquid.
 No dust, floating fiber and metal particles.
 It must be installed in a firm and no vibration location.
 Keep away from electromagnetic disturbance.

If users demand any special installation, please contact us firstly.

Installation space and distance of one inverter shows as fig 2-1-A that space should be enough. For several inverters installation, it should adopt guide clapboard to ensure better cooling between each inverter shown as fig 2-1-B.

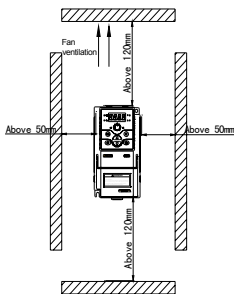

Fig 2-1-A Installation space distance

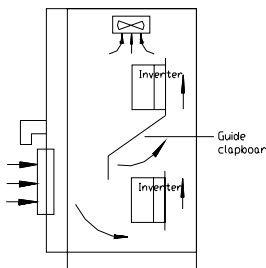

Fig 2-1-B Installation for several inverters

2.2 Installation Dimension

2.2.1 Dimension

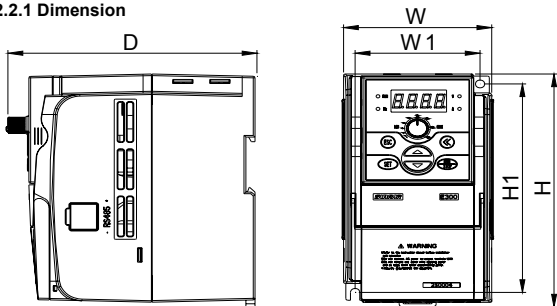

Fig 2-2-A Inverter installation dimension type I

Suitable model: E300-2S0002(B) / E300-2S0004(B) as fig 2-2-A.

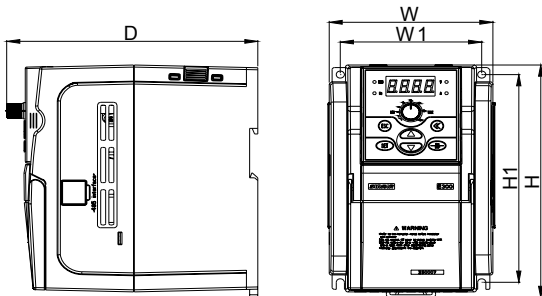

Fig 2-2-B Inverter installation dimension type II

Suitable model: E300-2S0007(B)~2S0022(B) / E300-4T0007(B)~4T00037(B) as fig 2-2-B.

E300 series installation dimension:

Model (3PH 380V)	Model (1PH 220V)	W1	W	H1	H	D	Screw spec
	E300-2S0002(B)	67.5	81.5	132.5	148	134.5	M4
	E300-2S0004(B)						
E300-4T0007(B)	E300-2S0007(B)	86.5	101.5	147.5	165	154.5	M4
E300-4T0015(B)	E300-2S0015(B)						
E300-4T0022(B)	E300-2S0022(B)	100	110	190	205	169.5	M5
E300-4T0037(B)							

2.2.2 Installation Size

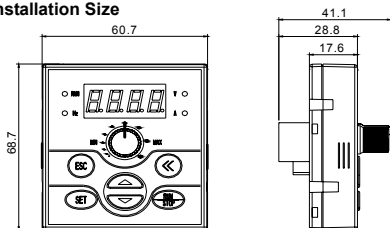

Fig 2-2-C Small keypad installation size

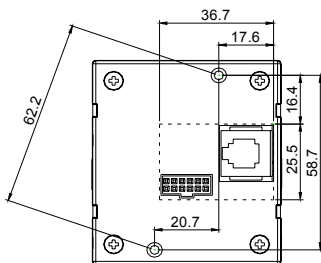

Fig 2-2-D Small keypad frame installation size

When using screw M3, please pay attention to hole place in broken line and hole size.

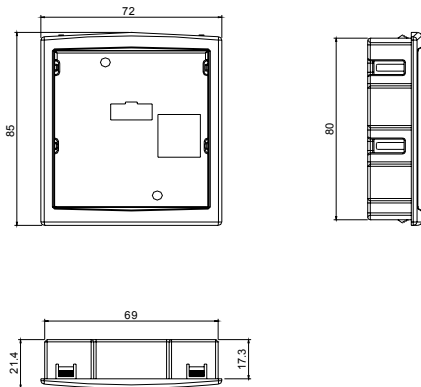

Fig 2-2-E Small keypad installation frame size

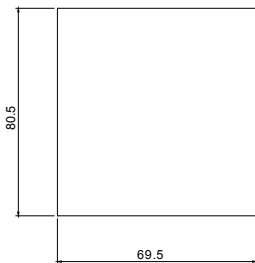

Fig 2-2-F Small keypad installation frame hole size

Note: recommend you refer to fig 2-2-F for using small keypad frame hole.

3 WIRING

3.1 Precautions

- (1) Install a middle breaker between inverter and power supply avoiding enlarging accident.
- (2) For reducing electromagnetic interface (EMI), please connect surge absorber to coil of electromagnetic contactors, relays etc.
- (3) Freq setting terminal AI, instrument circuit (AO) etc., these analog signals wire should be over 0.3mm^2 shield wire. Shield layer is connected with ground terminal CM less than 30m.
- (4) Wiring of relay input and output loop (X1 ~ X3) should choose over 0.75mm^2 intertwist or shield wire. Shield layer should be connected to control terminal CM less than 50m.
- (5) Separate control wire from main loop wire, parallel wiring should be part over 10cm, and across wiring should be vertical.
- (6) Wire of Inverter and motor should be less than 30m. When it is over 30m, it should decrease inverter carrier wave freq properly.
- (7) All down-lead should be tightened with terminals to ensure well-contact.
- (8) Compressive resistance of all down-lead should match with inverter volt.



Inverter output terminal U、V、W should not add absorber capacitor or other RC absorber shown as fig.3-1.

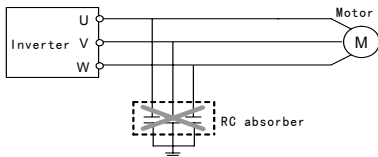

Fig 3-1 Output terminal does not allow connecting RC absorber

3.2 Wiring of External Components

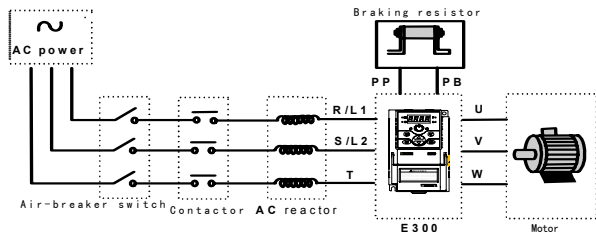

Fig 3-2 Inverter wiring

◆ Power

Please follow this manual for appointed input power specification.

◆ Air-breaker switch

1. When inverter is in maintenance or long-time nonuse, air-breaker switch isolates inverter and power supply.
2. When inverter input side has failure of short circuit or power low-volt, air-breaker switch can take protection.

◆ Contactor

Control power-on and power-off of inverter and load motor.

◆ AC reactor

1. Increase power factor;
2. Reduce power network harmonic wave input from inverter;
3. Weaken imbalance effect on three phase power volt.

◆ Braking resistor

In the situation of regenerative braking, avoiding bringing volt too high. Recommended specification for the devices as following:

Model	Applied motor (KW)	Wire spec (main circuit) (mm ²)	Air-breaker (A)	Magnetic contactor (A)
E300-2S0002(B)	0.25	1.5	10	6
E300-2S0004(B)	0.4	1.5	16	6
E300-2S0007(B)	0.75	2.5	20	12
E300-2S0015(B)	1.5	2.5	32	18
E300-2S0022(B)	2.2	6	32	18
E300-4T0007(B)	0.75	1.0	10	6
E300-4T0015(B)	1.5	1.5	16	12
E300-4T0022(B)	2.2	4	16	12
E300-4T0037(B)	3.7	4	20	18

3.3 Basic Wiring

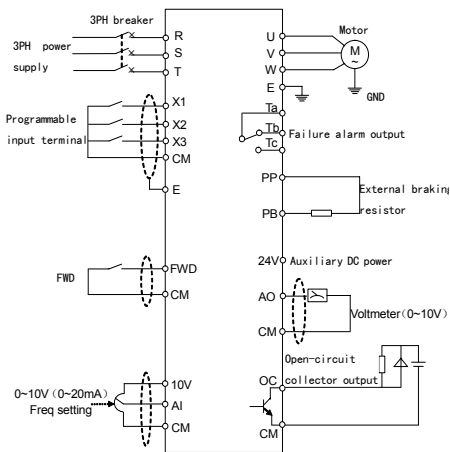
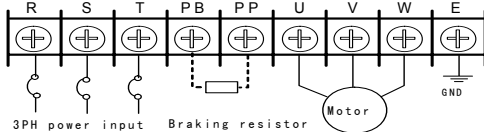

Fig 3-3 Inverter basic wiring

3.4 Wiring of Main Loop Terminal

(1) Type I (Suitable model: E300-4T0007(B)~E300-4T0037(B))



Terminal description:

Terminal	Function	Terminal	Function
PP	Positive terminal of DC negative	PB	Braking resistor can be connected between PP and PB.
R, S, T	Connect 3PH AC 380V power supply	U, V, W	Connect 3PH AC 380V motor
E	GND		

(2) Type II (Suitable model: E300-2S0002(B)~E300-2S0022(B)):

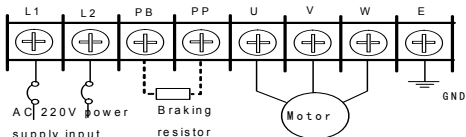

Terminal description:

Terminal	Function	Terminal	Function
PP	Positive terminal of DC negative	PB	Braking resistor can be connected between PP and PB.
L1、L2	Connect 1PH AC 220V power supply	U、V、W	Connect 3PH AC 220V motor
E	GND		

3.5 Wiring of Control Loop Terminal

(1) Control loop terminal:



(2) Function description of control loop terminal:

Type	Terminal	Function	Note
Power supply	10V	Provide +10V(0~20mA) power	
	24V	Provide +24V(0~50mA)power (CM terminal as this power grounding)	
Analog input	AI	Volt (current) signal input terminal	0~10V (0~20mA)
	CM	Public terminal of input (output) signal 10V and 24V power grounding)	
Control terminal	X1	Multi-function input terminal 1	Specific function for multi-function input terminals, please refer to parameter [F1.7] ~ [F1.9] for setting. Terminal and CM terminal close that is valid.
	X2	Multi-function input terminal 2	
	X3	Multi-function input terminal 3	
	FWD	FWD order input terminal	FWD-CM decides running direction when panel control mode. It's valid when close with CM terminal.
Analog output	AO	Programmable volt signal output terminal and external voltmeter (set by [F1.4])	Volt signal output 0~10V
OC output	OC	Programmable open-circuit collector output set by [F1.11]	Max load current 150mA, max endurable volt 24V
Programmable output	TA TB TC	Normal TA-TB close and TA-TC open appointed function is valid; TA-TB open and TA-TC close. Parameter [F1.12] selects output function.	Contactory capacity: AC 250V, 1A resistive load.

3.6 Wiring of RS485 Interface and External Keyboard

- (1) Wiring mode of RS485 interface:
 (2) RS485 interface adopts 8P "crystal pin" phone line and external keyboard interface adopts 8P "crystal pin" net line.

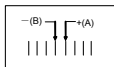

Suitable model: E300-2S0002(B) ~ E300-2S0022(B) / E300-4T0007(B) ~ E300-4T0037(B)

RS485 interface

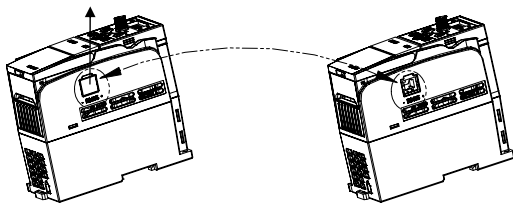

Fig 3-4-A Wiring mode I

External keyboard interface

External keyboard interface

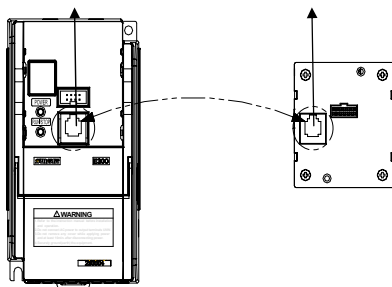

Fig 3-4-B Wiring mode II



E300B series has communication function. For this using, please refer to appendix explanation.
 When inverter failure, RUN/STOP light on cover will display.

4 PANEL OPERATION

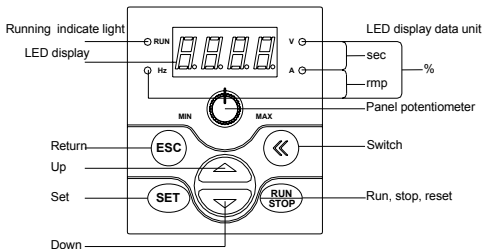







Fig 4-1 Operation panel layout

Note: E300 series keyboard interface can not be compatible with other Sunfar series keyboard. Please do not use confusedly.

4.1 Key Function Description

Key	Function
LED display	Display inverter current running state parameter and set parameter.
A. Hz. V	Corresponding unit of main LED display data
RUN	Operation indicator light means there is output volt from output terminal U, V, W during inverter running.
	Data modification key for modifying function code or parameter. During monitor mode, if freq order channel is digital set mode [F0.0]=0), press this key directly to modify freq setting value.
	Return key. During normal monitor mode, press this key and enter non-normal monitor mode/ monitor parameter check mode which can check inverter running state parameter. During any operation state, only press this key that can return to last state.
	Set key ensures current state or parameter (parameter stores in inner storage) and enters next function menu.
	Run and stop order key. When order channel chooses panel control [F0.2] =###0), this key is valid. It is trigger key. During inverter stop state, press this key and start inverter running. During inverter running state, press this key to input stop order for running. During inverter failure state, this key as failure reset key.
	Switch key. During any state for modifying data by data, press this key to choose modified data which may display.
	Panel potentiometer. When inverter running freq is set by potentiometer (F0.0=3) , you may decrease and increase running freq by rotating potentiometer knob.

4.2 Panel Operational Method

(1) State parameter check (e.g.)

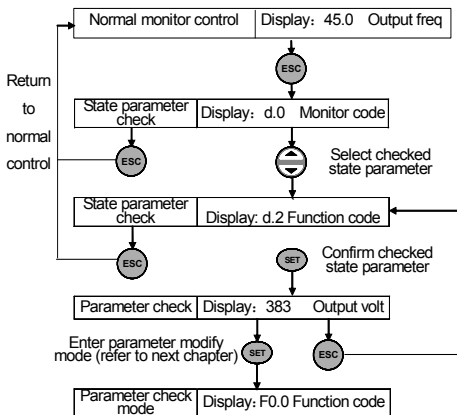

(2) Parameter check and modify (e.g.)

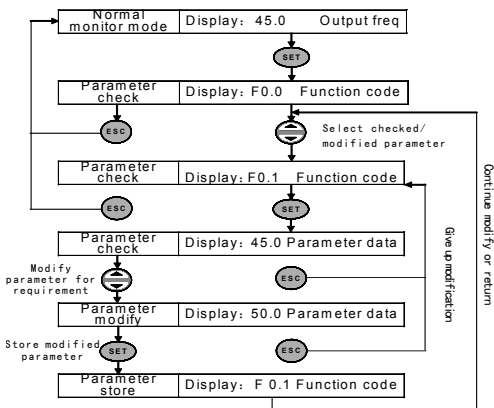

4.3 State Monitor Parameter List

Monitor code	Content	Unit
d-0	Inverter current output freq	Hz
d-1	Inverter current output current (virtual value)	A
d-2	Inverter current output volt (virtual value)	V
d-3	Motor rotate speed	rpm
d-4	Inverter inner DC volt	V
d-5	Inverter input AC volt (virtual value)	V
d-6	Set freq	Hz
d-7	Analog input AI	V
d-8	Running linear speed	
d-9	Set linear speed	
d-10	Input terminal state	
d-11	Module temperature	°C
d-12	Analog output AO	V
d-13	Reserved	
d-14	1st failure record	
d-15	2nd failure record	
d-16	3rd failure record	
d-17	4th failure record	
d-18	Output freq of last failure	Hz
d-19	Output current of last failure	A
d-20	Output volt of last failure	V
d-21	DC volt of last failure	V

4.4 Inverter Simple Operation

4.4.1 Inverter initialization set

(1) Freq input channel selection ([F0.0])

Inverter initialization set is different based on each model. Set this parameter as 0, inverter freq is set by panel number.

(2) Operation input channel selection ([F0.2])

Inverter initialization set is different based on each model. Set this parameter as [F0.2] =###0, inverter stop and startup is controlled by the key of operation  panel

4.4.2 Simple Operation



Forbid connect power supply to inverter output terminals U/V/W.

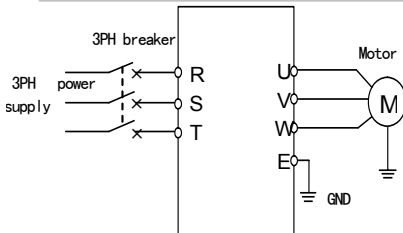





Fig 4-2 Wiring of simple running

- ① Please wire as fig 4-2;
- ② Be sure correct wiring then power on. Inverter displays "P.oFF", then "0";
- ③ Be sure [F0.0] = 0;
- ④ Based on inverter nameplate data for applied motor, please set parameter [F0.12] and [F0.13];
- ⑤ Press key  to start inverter, and inverter outputs freq 0 and displays "0.0";
- ⑥ Press key  for UP function to increase set freq. Inverter output freq increases and motor rotate speed increases;
- ⑦ Check motor running is normal or not. If any abnormal, please stop running immediately and power-off. Then, check the reasons and run again;
- ⑧ Press key  for DOWN function to decrease set freq;
- ⑨ Press key  again to stop running and power-off.



Manufacture setting value of carrier wave freq is fixed between 1.5-12KHz. If motor without load and under high carrier wave freq running, it may cause slight shock. So, please decrease carrier wave freq value (parameter [F0.8]) .

5 PARAMETER LIST

Function	Code	Name	Setting range	Minimum Unit	Manu setting	Modify Limit
Basic operation parameter unit	F0.0	Freq input channel / mode selection	0: Digital setting 1: External input signal (0~10V / 0~20mA) 2: Serial communication terminal (E300B series) 3: Panel potentiometer 4: External terminal selection	1	3	
	F0.1	Freq digital setting	0.00 ~ upper freq	0.1	0.0	
	F0.2	Operation channel and mode selection	1st part of LED: Operation channel selection 0: Control by keypad 1: Control by external terminal 2: Serial communication terminal (E300B series) 2nd part of LED: Operation mode selection 0: Two-line mode 1 1: Two-line mode 2 2: Three-line mode 3rd part of LED: Reversal avoidance 0: Invalid 1: Valid 4th part of LED: Self-startup when power-on 0: Prohibit 1: Allow	1	1000	
	F0.3	Lower freq	0.0 Hz ~ [F0.4]	0.1	0.0	
	F0.4	Upper freq	[F0.3] ~ 1000 Hz	0.1	50.0	
	F0.5	Acc time	0.1 ~ 600.0 S	0.1	10.0	
	F0.6	Dec time	0.1 ~ 600.0 S	0.1	10.0	
	F0.7	Acc / dec characteristics parameter	0: Linear acc / dec 1: S curve acc / dec	1	0	
	F0.8	Carrier wave freq	1.5 ~ 12.0 KHz	0.1	8.0	
	F0.9	Modulate mode	0: Asynchronism 1: Synchronization	1	0	×
	F0.10	Parameter read-in protection	1: Only allow to modify parameter F0.1 and this parameter 2: Only allow to modify this parameter Other data: all parameter can be allow to modify	1	0	
	F0.11	Torque boost	0.0 ~ 20.0 (%)	0.1	6.0	
	F0.12	Basic running freq	5.0 Hz ~ upper freq	0.1	50.0	
F0.13	Max output volt	25 ~ 250V, 50 ~500V	1	220, 440		

	F0.14	Jog acc time	0.1 ~ 600.0 S	0.1	10.0	
	F0.15	Jog dec time	0.1 ~ 600.0 S	0.1	10.0	
I/O Parameter Unit	F1.0	AI input lower volt	0.0V ~ [F1.1]	0.1	0.0	
	F1.1	AI input upper volt	[F1.0] ~ 10.0V	0.1	10.0	
	F1.2	Min setting freq	0.0 Hz ~ [F1.3]	0.1	0.0	
	F1.3	Max setting freq	[F1.2] ~ 1000 Hz	0.1	50.0	
	F1.4	Analog output selection	0: Output freq 1: Output current 2: Output volt	1	0	
	F1.5	AO output lower limit	0.0V ~ [F1.6]	0.1	0.0	
	F1.6	AO output upper limit	[F1.5] ~ 10.0V	0.1	10.0	
	F1.7	Function selection of input terminal 1 (0 ~ 12)	0: Control terminal idle 1: Multi-speed control 1 2: Multi-speed control 2 3: Multi-speed control 3 4: FWD jog control 5: REV jog control 6: Freq setting channel selection 1 7: Freq setting channel selection 2 8: Free stop control 9: Three-line mode running control 10: DC braking control 11: REV control 12: Failure reset	1	11	×
	F1.8	Function selection of input terminal 2 (0 ~ 12)		1	1	×
	F1.9	Function selection of input terminal 3 (0 ~ 12)		1	2	×
	F1.10	Reserved				
	F1.11	Output terminal OC function selection	0: During inverter running 1: Freq reach 2: Freq level check (FDT) 3: Overload check out 4: Freq reaches upper limit 5: Freq reaches lower limit 6: During zero speed running 7: Low-volt stop 8: Inverter failure	1	0	
	F1.12	Relay output TA/TB/TC function selection		1	8	
	F1.13	Freq reach check out amplitude	0.0~ 20 Hz	0.1	5.0	
	F1.14	FDT (freq level) set	0.0~1000 Hz	0.1	10.0	
F1.15	FDT output delay time	0.0~ 20.0 S	0.1	2.0	×	
F1.16	Overload warning level	50~200 (%)	1	110		

	F1.17	Overload warning delay time	0.0 ~ 20.0 S	0.1	2.0	×
Auxiliary running parameter unit	F2.0	Startup freq	0.0 ~ 50.0 Hz	0.1	1.0	
	F2.1	Startup freq lasting time	0.0 ~ 20.0 S	0.1	0.0	×
	F2.2	Stop mode	0: Dec stop 1: Free stop	1	0	
	F2.3	DC braking initial freq when stop	0.0 ~ 500.0 Hz	0.1	3.0	
	F2.4	DC braking action time when stop	0.0 ~ 20.0 S	0.1	0.0	×
	F2.5	DC braking action volt when stop	0 ~ 50 (%)	1	10	
	F2.6	FWD jog freq	0.0 Hz~ upper freq	0.1	10.0	
	F2.7	REV jog freq	0.0 Hz ~ upper freq	0.1	10.0	
	F2.8	Acc moment level	110 ~ 200 (%)	1	170	
	F2.9	Motor overload protection coefficient	50 ~ 110 (%)	1	100	
	F2.10	Initial volt of dynamic braking (E300B series)	300 ~400V 600 ~ 800V	1	370 740	
Multi-speed and senior running parameter unit	F3.0	Multi-speed freq 1	0.0 Hz ~ upper freq	0.1	35.0	
	F3.1	Multi-speed freq 2	0.0 Hz ~ upper freq	0.1	15.0	
	F3.2	Multi-speed freq 3	0.0 Hz ~ upper freq	0.1	3.0	
	F3.3	Multi-speed freq 4	0.0 Hz ~ upper freq	0.1	20.0	
	F3.4	Multi-speed freq 5	0.0 Hz ~ upper freq	0.1	25.0	
	F3.5	Multi-speed freq 6	0.0 Hz ~ upper freq	0.1	30.0	
	F3.6	Multi-speed freq 7	0.0 Hz ~ upper freq	0.1	35.0	
	F3.7	Linear speed coefficient setting	0.01 ~ 10.00	0.01	1.00	
	F3.8	Monitor parameter selection	0 ~ 21	1	0	
	F3.9	Parameter check and modification authority	0 ~ 9999	1	1700	
F3.10	Parameter initialization	0: No action 1: Standard initialization 2: Eliminate failure record 3: Complete initialization	1	0	×	

	F3.11	Low-volt protection level	180 ~ 230V 360 ~ 460V	1	200 400	
	F3.12	Over-volt limitation action level	350 ~ 400V 700 ~ 800V	1	380 760	
	F3.13	Current limit amplitude level	150 ~ 250 (%)	1	200	
	F3.14	Program version	1800 ~ 1899	1	1800	
Communication function parameter unit	F4.0	Communication setting (E300B series)	The 1st part of LED: Baud rate selection 0: Reserved 1: 1200 bps 2: 2400 bps 3: 4800 bps 4: 9600 bps 5: 19200 bps The 2nd part of LED: Data format selection 0: No check 1: Even check 2: Odd check The 3rd part of LED: Protocol selection 0: RS485 protocol 1: MODBUS communication protocol The 4th part of LED: Reserved	1	0114	
	F4.1	Master address (E300B series)	0 ~ 30	1	1	
	F4.2	Master response delay	0 ~ 1000 ms	1	5	
	F4.3	Communication auxiliary function setting	The 1st part of LED: Inverter master and slave set 0: This inverter as slave 1: This inverter as master The 2nd part of LED: Action selection if communication failure 0: Stop 1: Keep state The 3rd and 4th part of LED: Reserved	1	0010	
	F4.4	Communication overtime checkout time (E300B series)	0.0 ~ 50.00 Hz	0.01	3.00	
	F4.5	Linkage setting proportion	0.1 ~ 10.0	0.1	1.0	
	F4.6	Reserved				

6 DESCRIPTION OF SPECIFIC FUNCTIONS

6.1 Basic operation parameter unit

F0.0 Freq input channel/mode selection Setting range: 0 ~ 4

Select setting channel/mode of inverter running freq.

0: Digital set

Inverter setting freq is set by parameter [F0.1].

1: External input signal

Running freq is set by external input volt signal (0~10V) or current signal (0~20mA). Please refer to parameter [F1.0] and [F1.1] for explanation of relative characteristics.

2: Serial communication terminal

By serial RS485 interface, receive freq setting order from PC or master.

3: Panel potentiometer

Running freq is set by panel potentiometer.

4: External terminal selection

By external multi-function terminals, confirm freq input channel (selection of function terminal is set by parameter [F1.7]~[F1.9]).

Freq set selects terminal 2	Freq set selects terminal 1	Freq setting channel
0	0	Digital set
0	1	External input signal (0~10V/0~20mA)
1	0	RS485 interface
1	1	Panel potentiometer

Note: Terminal and CM closed is valid as 1.

F0.1 Freq digital set

Setting range: 0.0 Hz ~upper freq

When freq input channel selects digital set ([F0.0] = 0), inverter output freq is controlled by this value. Under operation panel normal monitor mode, press key  to modify this parameter directly.

F0.2 Operation channel and mode selection Setting range: 0000 ~ 1122

Select inverter operation order channel and the function of key  .

1st of LED: Operation order channel selection

0: Keypad control

Inverter running order is controlled by key . Under this mode, inverter output phase sequence will be influenced by external control terminal FWD state. When FWD and CM connect, inverter outputs negative phase sequence; whereas, inverter outputs positive phase sequence when FWD and CM disconnect.

1: External terminal control

Inverter running order is controlled by close or open state of external terminal FWD, multi-function terminal X1~X3 (REV control terminal) and CM terminal. The mode is confirmed by 2nd of LED.

2: Serial communication terminal

Inverter running order receives PC or master order through serial interface. During linkage control, this sets as master and selects this mode.

2nd of LED: Operation order mode selection

0: Two-line mode 1 (default mode)

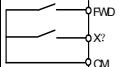
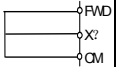
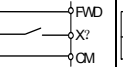
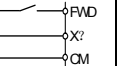
Order	Stop order		FWD order	REV order
Terminal state				

Two-line mode must select one input terminal X? as REV control terminal (please refer to explanation of [F1.7]~[F1.9])

1: Two-line mode 2

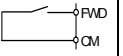
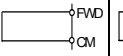
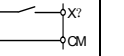
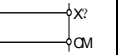
Order	Stop	Running	FWD	REV
Terminal state				

2: Three-line mode

Three-line mode must select one input terminal X? as three-line running control terminal, and one input terminal X? as REV control terminal (please refer to explanation of parameter [F1.7]~[F1.9]). Parameter [F1.7]~[F1.9] select random two from input terminal X1~X3.

Switch function explanation as below:

- SW1 (three-line running control terminal) — inverter stop trigger switch
- SW2 (FWD) — FWD trigger switch
- SW3 (REV control terminal) — REV trigger switch

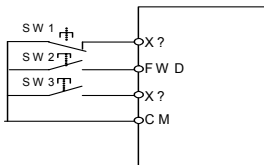

Fig 6-1 Wiring diagram of three-line control mode

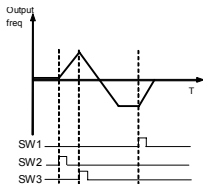

Fig 6-2 Freq output diagram of three-line

3rd of LED: Avoid REV

0: Invalid for avoiding REV

1: Valid for avoiding REV

4th of LED: Self-startup when power-on

0: Forbid self-startup when power-on

1: Permit self-startup when power-on

F0.3 Upper freq

Setting range: 0.0 Hz ~ [F0.4]

It can set hysteresis function, avoiding set fluctuation around zero freq. When decreasing set freq is lower than f ($f = \text{lower freq} - 2\text{Hz}$), inverter runs under zero freq. Increasing set freq, when set freq is lower than lower freq, inverter runs under zero freq shown as fig 6-3:

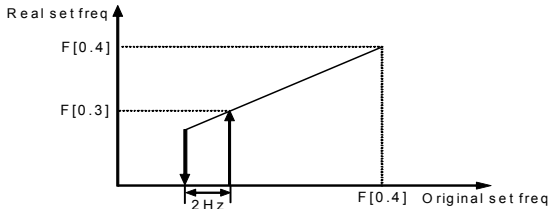

Fig 6-3 Lower freq action diagram

F0.4 Upper freq	Setting range: [F0.3] ~ 1000 Hz
------------------------	--

F0.5 Acc time	Setting range: 0.1 ~ 600.0 S
----------------------	-------------------------------------

F0.6 Dec time	Setting range: 0.1 ~ 600.0 S
----------------------	-------------------------------------

Define inverter variable up and down velocity of output freq.

Acc time: Required time is from output freq 0.0Hz up to upper freq [F0.4].

Dec time: Required time is from output freq [F0.4] decreasing to 0.0Hz.

F0.7 Acc/ dec characteristics	Setting range: 0 ~ 1
--------------------------------------	-----------------------------

Set inverter acc and dec characteristics parameter.

1st of LED: Inverter acc/ dec curve type set shown as fig 6-4.

0: Beeline acc/ dec

Inverter output freq follows fixed velocity increasing or decreasing. For most load, it can choose this mode.

1: S curve acc/ dec

Inverter output freq follows change velocity increasing or decreasing in order to decrease noise and vibration during acc/ dec, and reduce load impact during startup and stop.

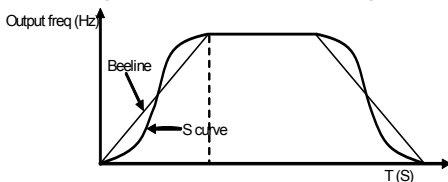

Fig 6-4 Acc & dec curve

F0.8 Carrier wave freq	Setting range: 1.5 ~ 12.0 KHz
-------------------------------	--------------------------------------

It is used for inverter inner power module switch freq.

Carrier wave mainly works on freq noise and thermal effect during running. When require running without noise, please increase carrier wave freq value properly, but inverter max load capacity will decrease, and increase disturbance to environment. For long motor line occasion, it may increase leakage between motor lines or lines and earth. When environmental degree is high, motor load is heavy or any failure due to above reasons, it should decrease carrier wave freq properly to improve inverter thermal character.

F0.9 Modulate mode	Setting range: 0 ~ 1
---------------------------	-----------------------------

Modulate mode selection:

0: Asynchronous modulate mode

1: Synchronous modulate mode

F0.10 Parameter read-in protection**Setting range: 0 ~ 9999**

It is used for avoiding any data wrong modification.

1: Only allow modifying parameter [F0.1] and this parameter

2: Only allow modifying this parameter

Other data: all parameter can be modified

When forbid modifying parameters, it will display "--" if try to make any modification.



Some parameters can not modify when running. If try to modify, it will display "--". If modify parameters, please make any modification when inverter stops running.

F0.11 Torque boost**Setting range: 0.0 ~ 20.0 (%)**

It is used for improving inverter low freq torque characteristic. When runs under low freq, it will boost compensation for inverter output volt shown as fig 6-5.

$$\text{Boost volt} = \frac{[\text{F0.11}]}{100} \times [\text{F0.13}]$$

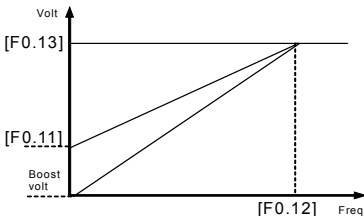

Fig 6-5 Torque boost diagram

F0.12 Basic running freq	Setting range: 5.0 Hz ~ upper freq
F0.13 Max output volt	Setting range: 25 ~ 250V / 50 ~ 500V

Basic running freq is inverter corresponding min freq of output max volt. Normally, it is motor rated freq.

Max output volt is inverter corresponding output volt of output basic running freq. Normally, it is motor rated volt.

The two function parameters should set based on motor parameters. If no any special requirement, no need to make any modification.

F0.14 Jog acc time	Setting range: 0.1 ~ 600.0 S
F0.15 Jog dec time	Setting range: 0.1 ~ 600.0 S

6.2 I/O parameter unit



Function parameter unit [F1.0]~[F1.1] defines external input signal upper and lower limit as freq set signal. E300 series allows input analog volt signal and analog current signal, analog current signal 0~20mA and corresponding volt signal 0~10V.

F1.0 AI input lower volt	Setting range: 0.0V ~ [F1.1]
F1.1 AI input upper volt	Setting range: [F1.0] ~ 10.0 V

[F1.0] and [F1.1] define analog input channel AI range following switch-on signal real state.

F1.2 Min set freq	Setting range: 0.0Hz ~ [F1.3]
F1.3 Max set freq	Setting range: [F1.2] ~ 1000 Hz

Analog input AI and set freq corresponding relationship shown as fig 6-6.

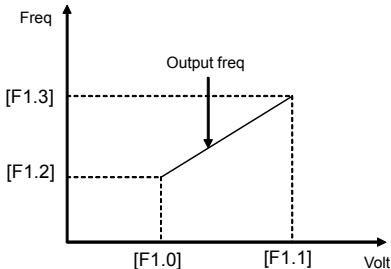

Fig 6-6 Corresponding relation diagram of analog input and set freq

F1.4 Analog output selection**Setting range: 0 ~ 2**

Meaning of selection analog output terminal AO.

1st of LED: Define meaning of analog output AO**0: Output freq**

Analog output (AO) amplitude is direct ratio to inverter output freq. Upper setting range ([F1.6]) of analog output is corresponding to upper freq.

1: Output current

Analog output (AO) amplitude is direct ratio to inverter output current. Upper setting range ([F1.6]) of analog output is corresponding to twice than inverter rated current.

2: Output volt

Analog output (AO) amplitude is direct ratio to inverter output volt. Upper setting range ([F1.6]) of analog output is corresponding to max output volt ([F0.13]).

F1.5 AO output lower limit**Setting range: 0.0 V ~ [F1.6]****F1.6 AO output upper limit****Setting range: [F1.5] ~ 10.0 V**

Define max and min value of analog output AO output signal shown as fig 6-7.

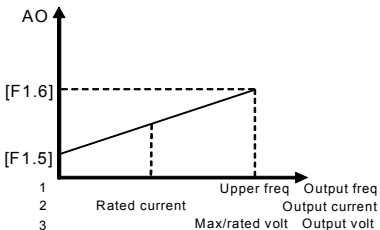

Fig 6-7 Analog output content of analog output terminal

F1.7 Input terminal 1 function selection**Setting range: 0 ~ 12****F1.8 Output terminal 2 function selection****Setting range: 0 ~ 12****F1.9 Input terminal 1 function selection****Setting range: 0 ~ 12**

Function definition of switch value input terminal X1~X3. Explanation as below:

0: Control terminal idle

1: Multi-speed control 1

2: Multi-speed control 2

3: Multi-speed control 3

Combination of multi-speed control terminal is used for selection multi-speed output freq. Each step freq is set by multi-speed control parameter function code unit ([F3.0]~[F3.6]).

4: FWD jog control

5: REV jog control

When running order channel selects external terminal valid, this parameter defines external jog signal input terminal.

6: Freq set channel selection 1

7: Freq set channel selection 2

When freq input channel selects (F0.0=4), inverter freq set channel is controlled by the two terminals state. The corresponding relation refers to parameter [F0.0] for explanation.

8: Free stop control

Close this parameter corresponding terminal that inverter will lock output.

9: Three-line mode running control

When running order terminal combination mode selects three-line mode, the external terminal defined by this parameter is inverter stop trigger switch. Three-line control mode refers to function code [F0.2] for explanation.

10: DC braking control

When inverter stops, if the terminal defined by this parameter is closed, it will start DC braking function till this terminal cuts when output freq is lower than DC braking initial freq. DC braking relative parameters refer to [F2.3] ~[F2.5] for explanation.

11: REV control

12: Failure reset

External terminal defined by this parameter can achieve failure reset.

F1.10 Reserved

F1.11 Output terminal OC function selection Setting range: 0 ~ 8

F1.12 Relay output TA/TB/TC function selection Setting range: 0 ~ 8

It is used for defining meaning content of collector open-circuit output terminal OC and relay output contactor. Inner wiring diagram of collector open-circuit output terminal is shown as fig 6-8. When set function valid, output lower electrical level; when function invalid, output high-resistance state.

Relay contactor output: when set output function valid, normal open contactor TA-TC connect.

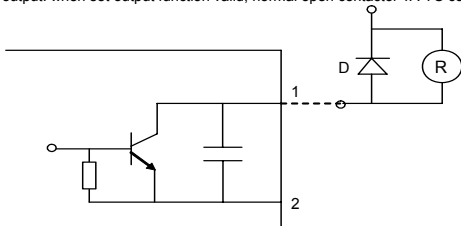

Fig 6-8 Inner wiring of OC output



When add external inductance component (as relay loop), it must be parallel connection fly-wheel diode D.

0: During inverter running

When inverter is during running, output valid signal (lower electrical level); output invalid signal (high-resistance) during stop state.

1: Freq reach

When inverter output freq is approach to setting freq range (confirmed by parameter [F1.13]), output valid signal (lower electrical level), otherwise, output invalid signal (high-resistance).

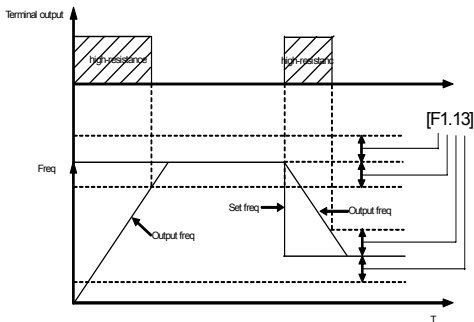

Fig 6-9 Freq reaching signal

2: Freq level check (FDT)

When inverter output freq is higher than FDT freq level, output valid signal (lower electrical level) by setting delay time. When inverter output freq is lower than FDT freq level, output invalid signal (high-resistance) by same delay time.

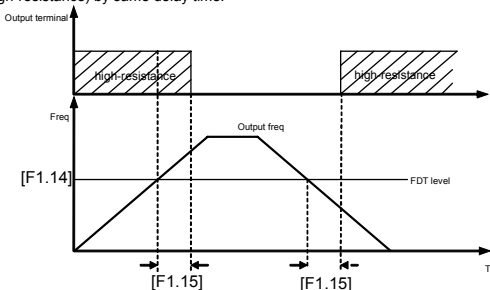

Fig 6-10 Freq level check signal (FDT)

3: Overload checkout

When inverter output current is higher than overload warning level, output valid signal (lower electrical level) by setting warning delay time. When inverter output current is lower than overload warning level, output invalid signal (high-resistance) by same delay time.

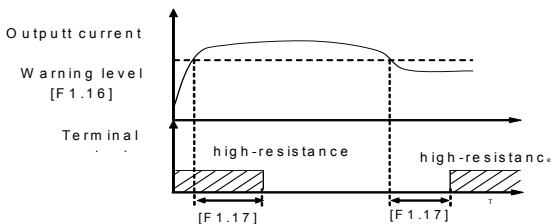

Fig 6-11 Overload warning

4: Freq reaches upper limit

When inverter output freq reaches upper freq, this terminal outputs valid signal (lower electrical level), otherwise, outputs invalid signal (high-resistance).

5: Freq falls to lower limit

When inverter output freq falls to lower freq, this terminal outputs valid signal (lower electrical level), otherwise, outputs invalid signal (high-resistance).

6: Zero speed running

When inverter running order is valid, output freq as 0, but output volt (DC braking), this terminal outputs valid signal (lower electrical level). When no output volt, outputs invalid signal (high-resistance).

7: Low-volt stop

When inverter DC side volt is lower than rated value, inverter stops and this terminal outputs valid signal (lower electrical level), otherwise, outputs invalid signal (high-resistance).

8: Inverter failure

When inverter failure stops running, output valid signal (lower electrical level). When normal, it is high-resistance state.

F1.13 Freq reaches checkout amplitude	Setting range: 0.0 ~ 20.0 Hz
--	-------------------------------------

Set freq reaching checkout amplitude defined by output terminal definition. When inverter output freq is within set freq plus-minus checkout amplitude, output terminal outputs valid signal shown as fig 6-9.

F1.14 FDT (freq level) set	Setting range: 0.0 ~ 1000 Hz
-----------------------------------	-------------------------------------

F1.15 FDT output delay time	Setting range: 0.0 ~ 20.0 S
------------------------------------	------------------------------------

Set freq check level. When output freq is higher than FDT setting value, output terminal outputs valid signal by setting delay time. When output freq is lower than FDT setting value, output terminal outputs invalid signal by same delay time.

F1.16 Overload warning level	Setting range: 50 ~ 200 (%)
-------------------------------------	------------------------------------

F1.17 Overload warning delay time	Setting range: 0.0 ~ 20.0 S
--	------------------------------------

Set overload warning level and warning delay time. When output current is higher than [F1.16] setting value, output terminal outputs valid signal (lower electrical level) by parameter [F1.17] setting delay time shown as fig 6-11.

6.3 Auxiliary running parameter unit

F2.0 Startup freq	Setting range: 0.0 ~ 50.0 Hz
--------------------------	-------------------------------------

F2.1 Startup freq lasting time	Setting range: 0.0 ~ 20.0 S
---------------------------------------	------------------------------------

Define relative characteristics of startup mode shown as fig 6-12.

Startup freq: for big inertia, heavy load, high start torque system, startup freq can overcome startup problems. Startup freq lasting time (parameter code [F2.1]) is the lasting time based on startup freq running which can set by real needs. When set as 0, startup freq is invalid.

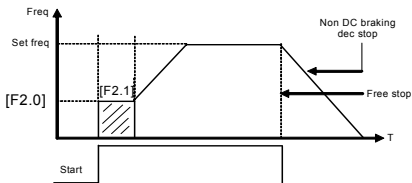

Fig 6-12 Startup and stop freq output curve

F2.2 Stop mode**Setting range: 0 ~ 1****0: Dec stop**

When stop, inverter decreases output freq to zero gradually by setting dec time.

1: Free stop

When stop, inverter outputs zero freq, lock output signal, motor runs freely to stop. When free stop, motor should restart after motor stops running completely; otherwise, it would happen over-current or over-volt failure.

F2.3 DC braking initial freq when stop**Setting range: 0.0 ~ 500.0 Hz****F2.4 DC braking action time when stop****Setting range: 0.0 ~ 20.0 S****F2.5 DC braking volt when stop****Setting range: 0 ~ 50 (%)**

Set DC braking parameters when stop.

When stop, DC braking initial freq ([F2.3]) sets during inverter stop process, when output freq is lower than this set parameter, inverter will lock output, start DC braking function. Stop DC braking action time is set by parameter [F2.4]. When stop DC braking action time as 0, stop braking function is invalid. Stop DC braking volt is percentage of inverter max output volt.

F2.6 FWD jog freq**Setting range: 0.0Hz ~upper freq****F2.7 REV jog freq****Setting range: 0.0Hz~upper freq**

Jog running is inverter special running mode. During jog signal valid, inverter runs by this parameter setting freq.

No matter inverter initial state is stop or running, all can receive jog signal. Transition of initial running freq and jog freq is by acc and dec time process ([F0.5], [F0.6]).

F2.8 Acc torque level**Setting range: 110 ~ 200 (%)**

Set allowable output level of torque current during inverter acc process.

During inverter acc process, torque limited level is set by [F2.8] as percentage of inverter rated current. E.g. set as 150%, it means max output current during acc is 150% of rated current. When inverter output current is beyond the range set by this parameter, it will prolong acc or dec time, in order to limit output current within this range shown as fig 6-13. So, for requiring short acc time state, it needs boost acc torque level properly.

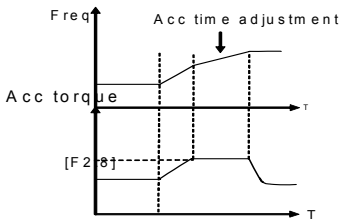

Fig 6-13 Acc torque and braking torque diagram

F2.9 Motor overload protection coefficient Setting range: 50 ~ 110 (100%)

Set inverter thermal-relay protection sensitivity for load-motor. When load-motor rated current value and inverter rated current is not matching, it can achieve motor thermal protection by setting this value.

Setting value is confirmed by below formula:

$$[F2.9] = \frac{\text{Motor rated current}}{\text{Inverter rated output current}} \times 100\%$$



When one inverter takes several motors for parallel connection running, inverter thermal-relay protection function will loss effect. In order to protect motor, we recommend installing thermal protection relay on each motor entrance terminal.

F2.10 Dynamic braking initial volt

Setting range: 300~400V / 600~800V

This parameter is valid for built-in braking unit inverter to define inverter inner braking unit action parameter. When inverter inner DC side volt is higher than dynamic braking initial volt, built-in braking unit acts. If there is external braking resistor, it will release inverter inner DC side energy by braking resistor to decrease DC volt. When DC side volt falls to some value ([F2.10]-50V), inverter built-in braking unit closes shown as fig 6-14.

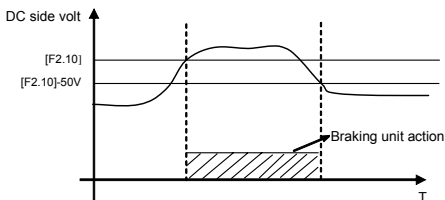

Fig 6-14 Dynamic braking

6.4 Multi-speed and advanced running parameter unit

F3.0 Multi-speed freq 1	Setting range: 0.0 Hz ~ upper freq
F3.1 Multi-speed freq 2	Setting range: 0.0 Hz ~ upper freq
F3.2 Multi-speed freq 3	Setting range: 0.0 Hz ~ upper freq
F3.3 Multi-speed freq 4	Setting range: 0.0 Hz ~ upper freq
F3.4 Multi-speed freq 5	Setting range: 0.0 Hz ~ upper freq
F3.5 Multi-speed freq 6	Setting range: 0.0 Hz ~ upper freq
F3.6 Multi-speed freq 7	Setting range: 0.0 Hz ~ upper freq

Set output freq of terminal control multi-speed running.

E300 series freq setting priority shown as below:

Priority class	Priority	Setting freq source
High ↓ Low	1	Jog freq (jog running valid)
	2	External terminals select multi-speed freq
	3	Freq setting channel selects parameter [F0.0]

Multi-speed freq priority is lower than jog freq, but higher than set channel selected freq.

F3.7 Linear speed coefficient set**Setting range: 0.01 ~ 10.00**

Set running linear speed and linear speed display data, or display other physical quantity which is direct ratio with output freq.

Running linear speed (d-8) = F3.7 × output freq (d-0)
 Set linear speed (d-9) = F3.7 × set freq (d-6)

F3.8 Monitor parameter selection**Setting range: 0 ~ 21**

Confirm operation panel display content under state monitor mode.

Monitor parameter selects confirmation LED display content.

Display data corresponding physical quantity that can refer to parameter state monitor parameter list for reference.

F3.9 Parameter check and modify right**Setting range: 0 ~ 9999**

It is for obtaining checkout code of some inner parameter check and modify right.

F3.10 Parameter initialization**Setting range: 0 ~ 9**

Modify parameter as manufacture setting.

0: No action

1: Standard initialization: (F0~F4 unit parameters except F0.0, F0.2, F3.14, all other parameters return to manufacture set.)

2: Clear failure record

3: Complete initialization: (F0~F4 unit parameters except F3.14, all other parameters return to manufacture set and clear failure record)

F3.11 Low-volt protection level**Setting range: 180 ~230V / 360 ~460V**

It is used for confirming DC side allowable lower limit volt under inverter normal running. For some low power line, it can decrease low-volt protection level properly to ensure inverter normal running.

Note: If power line volt is too low, motor output torque will decrease.

For constant power load and torque load, it will increase inverter input current if too low power line volt, so decrease inverter running reliability.

F3.12 Over-volt limit action level**Setting range: 350 ~400V / 700 ~800V**

During motor dec process, carry out volt losing speed protect valve. When inverter inner DC side pump increasing due to dec is higher than this parameter stated value, it will prolong dec time automatically shown as fig 6-15.

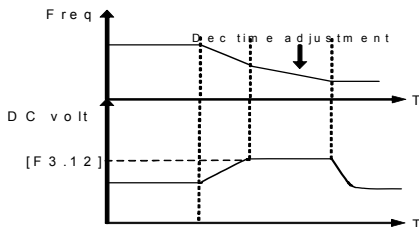

Fig 6-15 Volt losing speed protection during dec

F3.13 Current limit amplitude level **Setting range: 150 ~ 250 (%)**

It is used for inverter allowable output max current showing as inverter rated current percentage. Whatever running state (acc, dec or stable running), when inverter output current is higher than this parameter setting value, inverter will adjust output freq to limit current in rated range, avoiding over-current tripping.

F3.14 Program version **Setting range: 1800 ~ 1899**

Inverter control software version. Read only.

6.5 Communication function parameter unit

F4.0 Communication set **Setting range: 0000 ~ 0125**

Set characteristics related to communication.

1st of LED: Baud rate selection

0: Reserved 1: 1200bps 2: 2400bps

3: 4800bps 4: 9600bps 5: 19200bps

When use serial communication, make sure communication two sides have the same baud rate.

2nd of LED: Data format selection

0: No check 1: Even check 2: Odd check

When use serial communication, make sure communication two sides have the same data format.

3rd of LED: Protocol selection

0: RS485 protocol

1: MODBUS communication protocol

4th of LED: Reserved**F4.1 Local address****Setting range: 0 ~ 30**

Set local address when this inverter communication, only valid when this is Master. During communication process, this machine will only feedback corresponding frame when the data is matched to this address, and receive order.

RS485 communication address 31 is broadcasting address, and MODBUS communication 0 is broadcasting address. Regarding broadcasting data, slave performs order, but do not feedback corresponding data (refer to appendix communication protocol).

F4.2 Local responding delay**Setting range: 0 ~ 1000 ms**

It is the waiting time that when local receives right information code from control equip to sending responding data frame.

F4.3 Communication auxiliary function set **Setting range: 0000 ~ 0011****1st of LED: Inverter master and slave set**

0: This inverter as slave 1: This inverter as master

When several inverters require linkage synchronous control, one of them should set as master.

2nd of LED: Action selection after communication failure

0: Stop 1: Keep state

3rd of LED: Reserved; 4th of LED: Reserved**F4.4 Communication overtime checkout time** **Setting range: 0.0 ~ 100.0 S**

When it is beyond defined time interval by this parameter, and not receive right data signal, it judges communication failure. According to [F4.3] set running mode after communication failure, select stop or continued running.

F4.5 Linkage set proportion**Setting range: 0.1 ~ 10.0**

Define master and slave output freq proportion when linkage control.

This parameter unit of master inverter has no action. When RS485 interface achieves linkage synchronous control, slave running order and master is synchronous. Slave freq order follows below format:

Slave freq order = Master freq order × Slave [F4.5] set

F4.6 Reserved

7 FAULT DIAGNOSIS AND COUNTERMEASURES

7.1 Protective Function and Countermeasures

Code	Fault	Probable Cause	Solution
Fu.01	Over-current during inverter acc running	<ol style="list-style-type: none"> 1. Acc time is short 2. Motor direct startup during rotation 3. Set high for torque boost 4. Power supply volt is low 	<ol style="list-style-type: none"> 1. Prolong acc time 4. Start after motor stop 5. Decrease torque boost volt 6. Check power supply volt and decrease power
Fu.02	Over-current during inverter dec running	Dec time is short	Increase dec time
Fu.03	Over-current during inverter running or stop	<ol style="list-style-type: none"> 1. Load occurs mutation 2. Power supply volt is low 	<ol style="list-style-type: none"> 1. Decrease load fluctuation 2. Check power supply volt
Fu.04	Over-volt during inverter add running	<ol style="list-style-type: none"> 1. Input volt is high 2. Power supply is switched on-off frequently 	<ol style="list-style-type: none"> 1. Check power supply volt 2. Decrease acc torque set
Fu.05	Over-volt during inverter dec running	<ol style="list-style-type: none"> 1. Dec time is short 2. Input volt is abnormal 	<ol style="list-style-type: none"> 1. Prolong dec time 2. Check power supply volt 3. Install braking resistor or select braking resistor again
Fu.06	Over-volt during inverter running	<ol style="list-style-type: none"> 1. Power supply volt is abnormal 2. It has energy feedback load 	<ol style="list-style-type: none"> 1. Check power supply volt 2. Install braking unit, braking resistor or select braking resistor again
Fu.07	Over-volt when inverter stop	Power supply volt is abnormal	Check power supply volt
Fu.08	Low-volt during inverter running	<ol style="list-style-type: none"> 1. Power supply volt is abnormal 2. It has heavy load startup in power net 	<ol style="list-style-type: none"> 1. Check power supply volt 2. Power supply separately
Fu.09	Reserved		
Fu.10	Reserved		
Fu.11	Inverter disturbance	Wrong act due to electromagnetism disturbance	Add absorb circuit to inverter disturbance source
Fu.12	Inverter overload	<ol style="list-style-type: none"> 1. Heavy load 2. Acc time is short 3. Torque boost is high 4. Power supply volt is low 	<ol style="list-style-type: none"> 1. Reduce load or change for higher power range inverter 2. Prolong acc time 3. Decrease torque boost volt 4. Check power supply volt
Fu.13	Motor overload	<ol style="list-style-type: none"> 1. Heavy load 2. Acc time is short 3. Protection coefficient set is low 4. Torque boost is high 	<ol style="list-style-type: none"> 1. Reduce load 2. Prolong acc time 3. Increase motor overload protection coefficient [F2.9] 4. Decrease torque boost
Fu.14	Inverter over-heat	<ol style="list-style-type: none"> 1. Fan duct obstruct 2. Environment temperature is high 3. Fan damaged 	<ol style="list-style-type: none"> 1. Clear fan duct or improve ventilation condition 2. Improve ventilation condition and decrease carrier wave freq 3. Change fan
Fu.15 -Fu.19	Reserved		

Fu.20	Current check wrong	Current check equip or circuit damaged	1. Check socket line 2. Refer to manufacturer
Fu.21	Reserved		
Fu.40	Inner data memorizer wrong	Control parameter read-in wrong	Refer to manufacturer

7.2 Fault Record Inquiry

E300 series inverter records recent four times failure code and last inverter failure output parameter in order to find out the reasons.

Please refer to keypad operation way to look for information.

Monitor Item	Content	Monitor Item	Content
d-14	Record of 1st failure	d-18	Output freq of last failure
d-15	Record of 2nd failure	d-19	Output current of last failure
d-16	Record of 3rd failure	d-20	Output volt of last failure
d-17	Record of 4th failure	d-21	DC volt of last failure

7.3 Reset



Be sure to check failure reasons and exclude it before reset, which may cause inverter permanent damage. If can not reset or failure again after reset, please find out reasons. If not, it may damage inverter. When overload or over-heat protection, please prolong 5 minute to reset.

When inverter failure, you may select below ways for resuming normal running:

- I : When display failure code, press  key
- II : Close external multi-function terminal X? (failure reset) and CM, then cutoff.
- III : Send failure reset order through RS485 interface.
- IV : Cut power off.

Appendix I : RS485 COMMUNICATION PROTOCOL

1.1 Summary

E300 series derivative models, E300B series supports standard RS485 communication interface through PC/PLC to reach centralized monitor (send operation order, set inverter running parameter and read inverter running state) to meet special using requirement. This protocol is design for above function.

1.1.1 Protocol Content

This serial communication protocol defines transmission information and use format and it includes master-polling (or broadcasting) format, master coding method. Content includes function code of action, transferring data and error check. Slave response is the same structure, and it includes action confirmation, returning data and error check etc. If slave causes any error while receiving information or cannot finish action by master, it will send one fault signal to master as a response.

1.1.2 Using Application

1. Suitable product

The protocol is suitable for all Sunfar product series ranges inverter (C300 series, C320 series, E350 series, E380 series, E300 series etc.) , which also can be suitable for communication protocol of some other inverter brands.

2. Suitable mode

- (1) Inverter connects to PC/PLC control net of "single master multi-slave" with RS485.
- (2) Inverter connects to PC/PLC monitor background of "point to point" with RS485/ RS232 (transition interface).

1.2 BUS Structure and Protocol Description

1.2.1 BUS structure

1. Interface mode

RS485 (RS232 for choice, but need level translator)

2. Transmission mode

Asynchronism serial and semiduplex transmission mode. At the same time, only master or only slave can send data, and the other only can receive data. Data during serial Asynchronism communication, it would send by a frame to a frame as form of message.

3. Topological mode

In single-master system, there are 32 sites at most, one as master site and 31 slave sites. The setting range of slave address is 0~30, 31 (1FH) is broadcast communication address. Slave address must be exclusive in the network. Point to point mode is a special application as single master and multi-slaves topological mode, which is only one slave condition.

1.2.2 Protocol description

RS485 communication protocol is a kind of serial master-slave communication protocol, and

only an equipment as master can build protocol in network (named as "Inquire/Command"). Other equipments as slaves only can provide data to correspond master "Inquire/Command" or corresponding action for master's "Inquire/Command". Master is PC, industrial machine or programmable controller etc, and slave is inverter. Master not only visits some slave, but also sends broadcast information to all slaves. For single master "Inquire/Command", all slaves will return a signal as response; for broadcast information provided by master, slave no need offer any feedback to master.

1. Data structure

Three kinds of data transmission for choice:

- (1) 1 bit start-bit, 8 bit data bits, 1 bit stop-bit and no check bit.
- (2) 1 bit start-bit, 8 bit data bits, 1 bit stop-bit and even check bit (manufacturing setting) .
- (3) 1 bit start-bit, 8 bit data bits, 1 bit stop-bit and odd check bit.

2. Baud rate

Five baud rate for choice: 1200bps, 2400 bps, 4800 bps, 9600 bps, 19200 bps

3. Communication mode

- (1) Adopt master "poll", slave "response" point to point communication.
- (2) Use inverter keypad sets inverter serial interface communication parameter, including local address, baud rate and data format.



Master set must be same as inverter baud rate and data format.

4. Communication rule

- (1) There are at least 5-byte startup interval time between data frames, only the message with stated startup interval time is valid.
- (2) Mater waiting time and inverter longest corresponding time is 8-byte transmission time. If longer time, judge as communication failure.
- (3) If inverter does not receive any message after communication overtime checkout time (function code: F4.4) , judge as wire-break. Then, based on communication auxiliary function setting (function code: F4.3), it decides slave running state. (If receive any message during this time, it will control under it.)

1.2.3 Message structure

Length of each message is between 11~18 bytes (based on data format) ,Character type can be ASC II code and hex.

Data showing rule: hex, high number before and low number after. Shown as bellow:

- (1) ASC II code of data 3800H:

Data place	9	10	11	12
	Set data	Set data	Set data	Set data
Data value (hex)	33	38	30	30

(2) Hex of 3800H: (invalid place as "0")

Data place	9	10	11	12
	Set data	Set data	Set data	Set data
Data value (hex)	00	00	38	00

1. Master command frame

Send sequence	0	1	2	3	4	5	6	7	8	9	10	11	12	13	14	15	16	17
	Header		Slave addr.	Slave addr.	Order type	Operation order	Operation order	Data type	Data addr.	Data addr.	Set data	Set data	Set data	Set data	Check sum	Check sum	Check sum	Check sum
Definition			Slave addr.		Order area		Addr. area		Data area			Check area			0DH			

2. Slave corresponding frame

General data definition description for data frame

Send sequence	0	1	2	3	4	5	6	7	8	9	10	11	12	13	14	15	16	17
	Header		Slave addr.	Slave addr.	Slave correspond	Slave feedback	Slave feedback	Data type	Data addr.	Data addr.	Running data	Running data	Running data	Running data	Check sum	Check sum	Check sum	Check sum
Definition			Slave addr.		Corresponding area		Addr area		Data area			Check area			0DH			

(1) Header

This communication protocol defines: 2AH (ASC II code of character) and 5AH are available. When header is 2AH, all data behind header is ASC II code. When header is 5AH, all data behind header is hex code and invalid byte fill 0. Unaided headers of 2AH and 5AH aren't rightful header. There need waiting time above five bytes before sending header.

(2) Slave addr.

Set range of inverter address: 0~30, 31 (1FH) as broadcast communication address.

(3) Order type

Order type is during master sending data frame for defining action of this frame data. Based on different order type, frame length is different shown as below:

Data	Operation
0	Read slave state and characteristics information
1	Read slave running parameter
2	Read function code parameter
3	Modify inverter RAM area function code parameter, it will not save if power-off (no storage)
4	Send control order
5	Modify inverter EPROM area function code parameter, it will save if power-off
6~F	Reserved

(4) Operation order

Master gives control order to slave and it exists in all types of data frame (master sends 4th and 5th) shown as below:

Data	Operation	Data	Operation
00H	Invalid order	10H	Set slave running freq
01H	FWD running startup	11H	FWD running startup with running freq set
02H	REV running startup	12H	REV running startup with running freq set
03H	Stop	13H	Stop with running freq set
04H	Slave FWD jog	14H	FWD jog running with running freq set
05H	Slave REV jog	15H	REV jog running with running freq set
06H	Jog running stop	16H	Jog stop with running freq set
⋮	⋮	⋮	⋮
20H	Slave failure reset	30H	Reserved
21H	Slave urgent stop	31H	Reserved

(5) Slave correspond

Slave data correspond to master is for action feedback of master order frame. It exists in all type data frame shown as below:

Data	Definition	Data	Definition
0	Slave receives data for normal operation	1	Receive data beyond range
2	Slave running prohibit modifying data	3	Data modification prohibited by password
4	Try to read, reserve or hide parameter	5	Reserved
6	Appointed parameter code or invalid address (beyond limitation)	7	When adopt ASC II code transmission data, it exists invalid ASC II code character
8	Invalid order type or operation order	9~F	Reserved



When slave corresponding byte data is "6 ~ 8", frame length of corresponding frame is 11 byte.

Frame format is shown as below:

Slave correspond	0	1	2	3	4	5	6	7	8	9	10
	Header		Slave addr.	Slave addr.	Slave correspond	0	0	Check sum	Check sum	Check sum	Check sum
Definition		Slave addr.		Order/ corresponding area			Check area			0DH	

(6) State feedback

Slave sends back slave basic running state to master, which exists in all type data frame. (Slave feedback 4th and 5th) shown as below:

Data	Operation	Data	Operation
00H	Slave DC volt does not prepare well	10H	Reserved
01H	Slave FWD running	11H	FWD acc
02H	Slave REV running	12H	REV acc
03H	Slave stop	13H	Abrupt stop then startup
04H	Slave FWD jog running	14H	FWD dec
05H	Slave REV jog running	15H	REV dec
06H	Reserved	16H	Slave is during DC braking state
20H	Slave is during failure state	21H	Slave urgent stop

(7) Check sum

ASC II code value (ASC II code format) / hex data sum from slave address to set data/ running data.

(8) Tail

Hex "0DH", that's ASC II code of "CR" ASC II



When slave failure and state feedback data is "20H", feedback data frame 7th and 8th data (data addr.) as failure code.

1.3 Frame Format Description

When master sends header, tail or check sum of data frame abnormal, slave maybe can not be normal correspond.

1.3.1 Order type 0 —Read slave state and characteristics information

Master sends frame length 14 byte, slave corresponding frame length 18 byte.

Master send	0	1	2	3	4	5	6	7	8	9	10	11	12	13
	Header	Slave addr.	Slave addr.	0	Operation order	Operation order	Data type	0	0	Check sum	Check sum	Check sum	Check sum	Tail

Slave correspond	0	1	2	3	4	5	6	7	8	9	10	11	12	13	14	15	16	17
	Header	Slave addr.	Slave addr.	Slave correspond	State feedback	State feedback	Data type	Character information	Character information	Character information	Character information	Character information	Character information	Check sum	Check sum	Check sum	Check sum	Tail

Note: Slave offer different feedback of character information because of different data value of master sending frame.

Data Type (master send)		Character Information (slave correspond)					
6		7	8	9	10	11	12
0	Read slave model info.	Volt class	0	Power	Power	Power	Power
1	Read slave model info.	Reserved	Reserved	Reserved	Reserved	Reserved	Reserved
2	Read slave version	Reserved	Reserved	#	#	#	#
3	Read slave operation info.	Master control	Master freq set	Reserved	Reserved	Reserved	Reserved
4~F	Reserved	#	#	#	#	#	#

E.g. If master sending frame data value is zero, slave corresponding information is 400015. It means: 4 as volt class, 380V; 0 as character information value; 0015 as power, 1.5Kw.

1.3.2 Order type 1——Read slave running parameter

Master sending frame length is 14 byte, and slave corresponding frame length is 18 bytes.

Master send	0	1	2	3	4	5	6	7	8	9	10	11	12	13
	Header	Slave addr.	Slave addr.	1	Operation order	Operation order	0	Data type	Data type	Check sum	Check sum	Check sum	Check sum	Tail

Slave correspond	0	1	2	3	4	5	6	7	8	9	10	11	12	13	14	15	16	17
	Header	Slave addr.	Slave addr.	Slave correspond	State feedback	State feedback	0	Data type	Data type	Running data	Running data	Running data	Running data	Check sum	Check sum	Check sum	Check sum	Tail

Data type: For inverter monitor parameter item, E300 series monitor parameter item as follow:

Monitor Item	Data type	Slave Feedback Value
d.0	00	Output freq
d.1	01	Output volt
⋮	⋮	⋮
d.15	15	The 2nd failure record
⋮	⋮	⋮
d-21	21	The last failure DC current



Please refer to E300 series manual chapter four, 4.3 state monitor unit to check inverter monitor parameter.

1.3.3 Order type 2——Read function code parameter

Master sending frame length is 14 byte, and slave corresponding frame length is 18 byte.

Master send	0	1	2	3	4	5	6	7	8	9	10	11	12	13
	Header	Slave addr.	Slave addr.	N	Operation order	Operation order	Data type	Data addr.	Data addr.	Check sum	Check sum	Check sum	Check sum	Tail

Slave correspond	0	1	2	3	4	5	6	7	8	9	10	11	12	13	14	15	16	17
	Header	Slave addr.	Slave addr.	Slave correspond	State feedback	State feedback	Data type	Data addr.	Data addr.	Parameter data	Parameter data	Parameter data	Parameter data	Check sum	Check sum	Check sum	Check sum	Tail



Please refer to order type 3 and 5 for data type and data addr.

1.3.4 Order type 3—Modify RAM area function code parameter

1.3.5 Order type 5—Modify EPROM area function code parameter

Master sending frame length is 18 byte, and slave corresponding frame length is 18 byte.

Master send	0	1	2	3	4	5	6	7	8	9	10	11	12	13	14	15	16	17
	Header	Slave addr.	Slave addr.	0 5 5	Operation order	Operation order	Data type	Data addr.	Data addr.	Set data	Set data	Set data	Set data	Check sum	Check sum	Check sum	Check sum	Tail

Slave correspond	0	1	2	3	4	5	6	7	8	9	10	11	12	13	14	15	16	17
	Header	Slave addr.	Slave addr.	Slave correspond	State feedback	State feedback	Data type	Data addr.	Data addr.	Set data	Set data	Set data	Set data	Check sum	Check sum	Check sum	Check sum	Tail

Data type definition:

Function code unit	F0	F1	F2	F3	F4	F5	F6	F7	F8	F9	FC	FE	FF	FH	FL	FP
Data type	0	1	2	3	4	5	6	7	8	9	A	B	C	D	E	F

Function code relative addr.: e.g. Data addr. of F0.8、F1.8、F2.8、F#.8 is 8, but different data type.

Note: When slave can not finish master order, feedback setting data is 0000.

1.3.6 Order type 4——Send control order

Master sending frame length is 15 byte, and slave corresponding frame length is 18 byte. For normal operation, this kind of frame is most suitable.

Master send	0	1	2	3	4	5	6	7	8	9	10	11	12	13	14
	Header	Slave addr.	Slave addr.	4	Operation order	Operation order	Set data	Set data	Set data	Set data	Check sum	Check sum	Check sum	Check sum	Tail

Slave correspond	0	1	2	3	4	5	6	7	8	9	10	11	12	13	14	15	16	17
	Header	Slave addr.	Slave addr.	Slave correspond	State feedback	State feedback	0	Monitor item	Monitor item	Running data	Running data	Running data	Running data	Check sum	Check sum	Check sum	Check sum	Tail

Set data of master sending frame is set freq from master sending to slave.

Running data of slave corresponding frame is master sending running parameter which decides by set content from monitor item (function code: [F3.8]) in inverter function parameter unit, meantime, slave feedback this item monitor value.



Please refer to E300 series manual chapter five, function parameter unit, to check inverter function parameter unit.

1.4 Example

1.4.1 Read slave state and character information (order type 0)

Data set: read slave model.

Master send	Header	Slave addr.	Order type	Operation order	Data type	Data type	Check sum	Tail
Digit	1	2	1	2	1	2	4	1
E.g.	2A	30 30	30	30 31	30	30 30	30 31 38 31	0D
	5A	00 00	00	00 01	00	00 00	00 00 00 01	0D
Explain	Header	Addr. 00	0 order	Running startup	No data type		Adding hex	Tail

Data return: model is 2S0004.

Slave return	Header	Slave addr.	Slave correspond	State feedback	Data type	Character information	Check sum	Tail
Digit	1	2	1	2	1	6	4	1
E.g.	2A	30 30	30	30 33	30	32 30 30 30 30 34	30 32 34 39	0D
	5A	00 00	00	00 03	00	02 00 00 00 00 04	00 00 00 09	0D
Explain	Header	0 slave return	Slave receive data	Slave stop state	No data type	02 – volt class 2S 04 – power 0.4KW	Adding hex or adding algorism	Tail

1.4.2 Read slave running parameter (order type 1)

Data set: read d-6 (present set freq) .

Master send	Header	Slave addr.	Order type	Operation order	Data type	Data type	Check sum	Tail
Digit	1	2	1	2	1	2	4	1
E.g.	2A	30 30	31	30 30	30	30 36	30 31 38 37	0D
	5A	00 00	01	00 00	00	00 06	00 00 00 07	0D
Explain	Header	Addr. 00	1 order	Invalid order	D parameter unit	D parameter	Adding hex	Tail

Data return: return to present set freq 50.0 Hz.

Slave return	Header	Slave addr.	Slave correspond	State feedback	Display parameter	Data type	Running data	Check sum	Tail
Digit	1	2	1	2	1	2	4	4	1
E.g.	2A	30 30	30	30 33	30	30 36	30 31 46 34	30 32 36 34	0D
	5A	00 00	00	00 03	00	00 06	00 00 01 F4	00 00 00 FE	0D
Explain	Header	0 slave return	Slave receive data	Slave stop[D Parameter unit	No data type	Set freq 50.0 Hz	Adding hex	Tail

1.4.3 Read function code parameter (order type 2)

Data set: read parameter [F0.8]

Master send	Header	Slave addr.	Order type	Operation order	Data type	Data addr.	Check sum	Tail
Digit	1	2	1	2	1	2	4	1
E.g.	2A	30 30	32	30 30	30	30 38	30 31 38 41	0D
	5A	00 00	02	00 00	00	00 08	00 00 00 0A	0D
Explain	Header	Addr. 00	2 order	Invalid control order	F parameter unit	F parameter	Adding hex	Tail

Data return: carrier wave freq [F0.8]=8.0KHz.

Slave return	Header	Slave addr.	Slave correspond	State feedback	Data type	Data type	Return data	Check sum	Tail
Digit	1	2	1	2	1	2	4	4	1
E.g.	2A	30 30	30	30 33	30	30 38	30 30 35 30	30 32 35 30	0D
	5A	00 00	00	00 03	00	00 08	00 00 00 50	00 00 00 5B	0D
Explain	Header	0 slave return	Slave receive data	Slave stop state	F0 Parameter unit	F0.8	Return data as 8.0KHz	Adding hex	Tail

1.4.4 Modify RAM area function code parameter (order type 3)

Data set: modify data set freq [F0.1]=50.0Hz, not keep when stop.

Master send	Header	Slave addr.	Order type	Operation order	Data type	Data type	Set data	Check sum	Tail
Digit	1	2	1	2	1	2	4	4	
E.g.	2A	30 30	33	30 30	30	30 31	30 31 46 34	30 32 35 46	0D
	5A	00 00	03	00 00	00	00 01	00 00 01 F4	00 00 00 F9	0D
Explain	Header	Addr. 00	3 order	Invalid control order	F0 Parameter unit	F0. 1 Parameter	Set freq 50.0Hz	Adding hex	Tail

Data return: data correct set.

Slave return	Header	Slave addr.	Slave correspond	State feedback	Data type	Data addr.	Set data	Check sum	Tail
Digit	1	2	1	2	1	2	4	4	1
E.g.	2A	30 30	30	30 33	30	30 31	30 31 46 34	30 32 35 46	0D
	5A	00 00	00	00 03	00	00 01	00 00 01 F4	00 00 00 F9	0D
Explain	Header	0 slave return	Slave receive data	Slave stop state	F0 Parameter unit	F0.1	Set data 50.0HZ	Adding hex	Tail

1.4.5 Send control order (order type 4)

Data return: set slave 0 inverter FWD running freq 10.0 Hz.

Master send	Header	Slave addr.	Order type	Operation order	Set data	Check sum	Tail
Digit	1	2	1	2	4	4	1
E.g.	2A	30 30	34	31 31	30 30 36 34	30 31 43 30	0D
	5A	00 00	04	00 11	00 00 00 64	00 00 00 79	0D
Explain	Header	Addr. 00	4 order	FWD with freq set	Set freq 10.0 Hz	Adding hex	Tail

Data return: 0 inverter receives data normally.

Slave return	Header	Slave addr.	Slave correspond	State feedback	0	Monitor item	Running data	Check sum	Tail
Digit	1	2	1	2	1	2	4	4	1
E.g.	2A	30 30	30	30 31	30	30 30	30 30 36 34	30 32 34 42	0D
	5A	00 00	00	00 01	00	00 00	00 00 00 64	00 00 00 65	0D
Explain	Header	0 slave return	Slave receive data	Slave FWD running	Fixed data	Present display monitor d-0	Data set successfully	Adding hex	Tail

1.4.6 Modify EEPROM parameter (order type 5)

Data send: modify torque boost [F0.11]=6.0, store when stop.

Master send	Header	Slave addr.	Order type	Operation order	Data type	Data type	Set data	Check sum	Tail
Digit	1	2	1	2	1	2	4	4	1
E.g.	2A	30 30	35	30 31	30	30 41	30 30 33 43	30 32 36 44	0D
	5A	00 00	05	00 01	00	00 0B	00 00 00 3C	00 00 00 4D	0D
Explain	Header	Addr. 00	5 order	Slave FWD running	F0 Parameter unit	F0.11 Parameter	Data set	Adding hex	Tail

Data return: slave receives data normally.

Slave return	Header	Slave addr.	Slave correspond	State feedback	Data type	Data addr.	Set data	Check sum	Tail
Digit	1	2	1	2	1	2	4	4	1
E.g.	2A	30 30	30	30 31	30	30 41	30 30 33 43	30 32 36 38	0D
	5A	00 00	00	00 01	00	00 0B	00 00 00 3C	00 00 00 48	0D
Explain	Header	0 slave return	Slave receive data	Slave FWD running	F0 Parameter unit	F0.11	Data set successfully	Adding hex	Tail

Appendix II : MODBUS PROTOCOL

1. Communication Set

F4.0=X1XX, choose MODBUS RTU protocol.

F4.0=X0XX, choose RS485 protocol.

Note: X means as random number.

2. Communication Function

It is for master and inverter communication, including sending inverter operation order, modification function code parameter and read inverter running state, monitor parameter, failure information and function code parameter.

3. Protocol Format

MODBUS RTU format

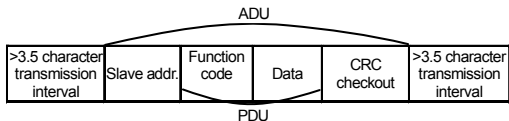

1.1 Protocol Format Explanation

1. Slave addr.

0 as broadcast addr., and slave addr. can be set as 1~30.

2. PDU part

(1) **Function code 03:** Read several inverter function parameter, running state, monitor parameter and failure information at most for reading six addr. serial inverter parameter.

Master send:

PDU part	03	Register initial addr.		Register number	
		High order	Low order	High order	Low order
Data length (Byte)	1	1	1	1	1

Slave correspond:

PDU part	03	Read byte number (2* register number)	Read content
Data length (Byte)	1	1	2* register number

(2) **Function code 06:** Modify single inverter operation order, running freq and function parameter.

Master send:

PDU part	06	Register initial addr.		Register data	
		High order	Low order	High order	Low order
Data length (Byte)	1	1	1	1	1

Slave correspond:

PDU part	06	Register initial addr.		Register data	
		High order	Low order	High order	Low order
Data length (Byte)	1	1	1	1	1

(3) Function code 10: Modify several inverter operation order, running freq and function parameter.

Master send:

PDU part	10	Register initial addr.		Register number		Content byte number	Register content
		High order	Low order	High order	Low order		
Data length (Byte)	1	1	1	1	1	1	2* register number

Slave correspond:

PDU part	10	Register initial addr.		Register number	
		High order	Low order	High order	Low order
Data length (Byte)	1	1	1	1	1

Note: Inverter stores from register of lowest addr. to highest addr. at most six function code. If any wrong, slave will correspond demurral.

Demurral correspond:

PDU part	0x80+ function code	Demurral code
Data length (Byte)	1	1

Demurral code means failure type:

Demurral code	Corresponding failure
01	Invalid function code
02	Invalid data addr.
03	Data beyond limitation
04	Slave invalid operation
20	Read too much parameter
21	Read stored and hided parameter
22	Slave running prohibits modification data
23	Data modification by password protection
24	Read parameter failure

CRC checkout:

CRC checkout	CRC low order	CRC high order
Data length (Byte)	1	1

CRC checkout function as follow:

```
unsigned int crc_chk_value(unsigned char *data_value, unsigned char length)
```

```
{
```

```
    unsigned int crc_value=0xFFFF;
```

```
    int i;
```

```
    while(length--)
```

```
    {   crc_value^=*data_value++;
```

```
        for(i=0;i<8;i++)
```

```
        { if(crc_value&0x0001)
```

```
            crc_value=( crc_value>>1)^0xA001;
```

```
        else
```

```
            crc_value= crc_value>>1;
```

```

    }

}

return(crc_value);

}

```

3. Communication Parameter Addr. Definition

Inverter parameter addr. distribution

Register definition	Register addr. space
Function parameter ⁽¹⁾	High order as function code unit number, and low order as function code tab. E.g., F1.11, the register addr. is F10B.
Monitor parameter	High order as 0xD0, and low order as monitor tab. E.g., d.12, the register addr. is D00C.
Operation order ⁽²⁾	0x1001
Freq set	0x1002
Inverter state ⁽³⁾	0x2000
Failure information ⁽⁴⁾	0x2001

Note:

(1) EEPROM may decrease its using life if write function code parameter frequently. For some parameter communication mode, it no need to store and only modify RAM value is ok. When write function parameter RAM value, only change F in register high order addr. into 0. If write RAM value of F1.11, the register addr. Should be 010B, but figured way of this register addr. can not use for reading inverter function parameter.

(2) Corresponding operation order of operation order code:

Operation order code	Operation order
0x0000	Invalid order
0x0001	FWD running startup
0x0002	REV running startup
0x0003	Stop
0x0004	Slave FWD jog
0x0005	Slave REV jog
0x0006	Jog running stop
0x0020	Slave failure reset

(3) Inverter state:

Inverter state code	Meaning
0x0000	Slave DC volt unprepared well
0x0001	During slave FWD running
0x0002	During slave REV running
0x0003	Slave stop
0x0004	During slave FWD jog running
0x0005	During slave REV jog running
0x0011	During FWD acc
0x0012	During REV acc
0x0013	Instantaneous stop then startup
0x0014	FWD dec
0x0015	REV dec
0x0016	Slave during DC braking state
0x0020	Slave during failure state

(4) High order of failure information code is 0, and low order corresponds to behind tab of inverter failure code Fu., e.g. Failure information code is 0x000C, which means inverter failure code is Fu.12.

1.2 Example

1.Start 1# inverter FWD running

Master claim:

Slave addr.	Function code	Register initial addr.		Register data		CRC checkout	
		High order	Low order	High order	Low order	Low order	High order
01	06	10	01	00	01	1D	0A

Slave correspond: Inverter FWD running returns to same data for master claim.

2. Set inverter running freq as 50. 0 Hz

Master claim:

Slave addr.	Function code	Register initial addr.		Register data		CRC checkout	
		High order	Low order	High order	Low order	Low order	High order
01	06	10	02	01	F4	2C	DD

Slave correspond: inverter running for 50.0 Hz returns to same data for master claim.

3. Read inverter current running freq, output current, inverter corresponding freq 50.0 Hz and output current 1.1A.

Master claim:

Slave addr.	Function code	Register initial addr.		Register number		CRC checkout	
		High order	Low order	High order	Low order	Low order	High order
01	03	D0	00	00	02	FC	CB

Slave correspond:

Slave addr.	Function code	Read character number	1 st register data		2 nd register data		CRC checkout	
			High order	Low order	High order	Low order	Low order	High order
01	03	04	01	F4	00	0B	FB	FA

4. Start 1# inverter FWD running and set inverter running freq as 40 Hz.

Master claim:

Slave addr.	Function code	Register initial addr.		Register number		Content byte number	1 st register data		2 nd register data		CRC checkout	
		High order	Low order	High order	Low order		High order	Low order	High order	Low order	High order	
01	10	10	01	00	02	04	00	01	01	90	AF	9F

Slave correspond:

Slave addr.	Function code	Register initial addr.		Register number		CRC checkout	
		High order	Low order	High order	Low order	Low order	High order
01	10	10	01	00	02	14	C8

Appendix III: BRAKING RESISTOR

During inverter running, if speed of controlled motor decreases too fast or shock of motor load too fast, its feedback energy may generate power into inverter capacitance that would cause damage of inverter itself. Inverter inner control will restrict based on load. If braking performance can not reach requirement, it needs external braking resistor to achieve energy release in time. External braking resistor as energy consuming mode would consume for power braking resistor. If so, power of braking resistor should select suitably. Below is SUNFAR recommended braking resistor power and resistor value. Based on load situation, user can select suitable value for SUNFAR inverter requirement.

Inverter model	Applied motor (KW)	Braking resistor power (KW)	Braking resistor value (Ω)	Braking torque (%)
E300-2S0002	0.2	0.1	250	100
E300-2S0004	0.4	0.1	150	100
E300-2S0007	0.75	0.1	100	100
E300-2S0015	1.5	0.2	70	100
E300-2S0022	2.2	0.4	50	100
E300-4T0007	0.75	0.1	400	100
E300-4T0015	1.5	0.2	300	100
E300-4T0022	2.2	0.4	200	100
E300-4T0037	3.7	0.6	125	100

Above recommendation is for 100% braking torque. If braking is not visible, please decrease braking resistor and increase braking resistor power class.



Braking resistor power is estimated value during braking resistor interval running situation. When braking resistor lasts long time work (above 5S), it should increase braking resistor power class properly under same resistor value.



Floor 5, 2nd Building, Catic Shahe Industrial Zone, Nanshan District, Shenzhen, PRC

Website: www.sunfardrive.com

TEL : +86-755-26910801 FAX : +86-755-26607756

Commercial Hotline : +86-755-26910801, 26609885, 26606885

Commercial FAX : +86-755-26607756, 26912599

After-service Hotline : +86-755-26910801